

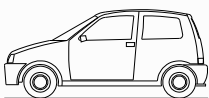







TABELLA AB**AUTO**

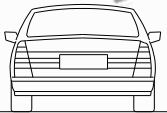
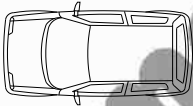
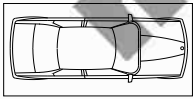
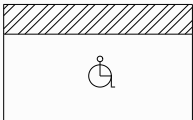
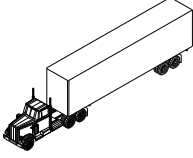
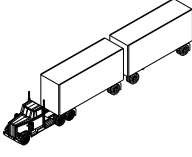
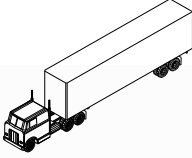
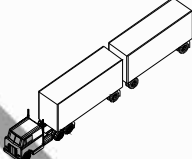



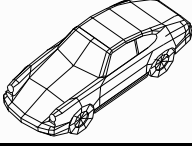
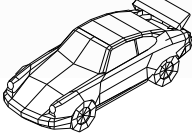
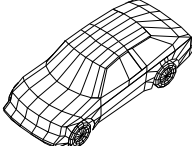

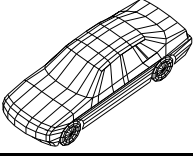
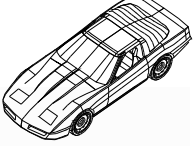
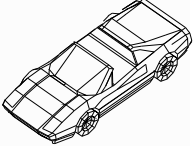
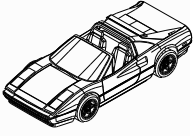
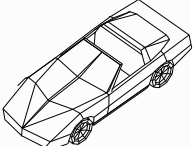
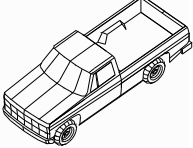
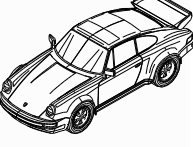
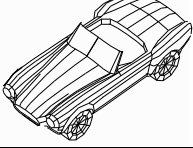

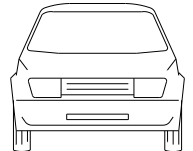

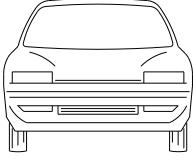
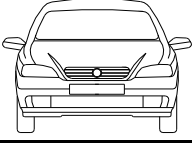
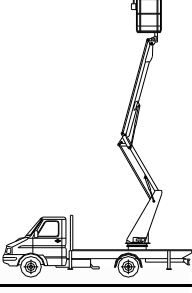
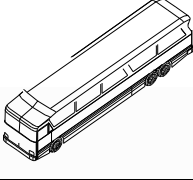

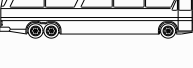
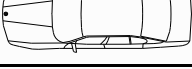
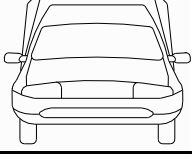
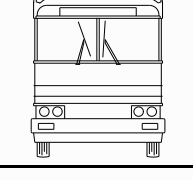
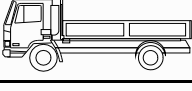
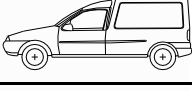
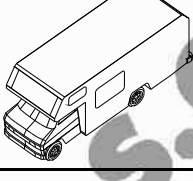
Produttore:
AEDITORIA ELETTRONICA
S.C.S. EDITRICE

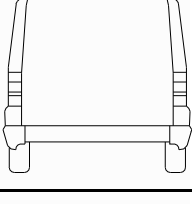
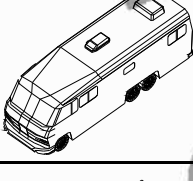
Formato:
DXF - DWG - WMF - BMP - EMF
- JPG

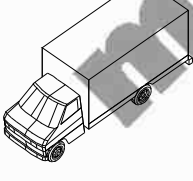
N.	NOME	FIGURA
1	Aut001 3.20-1.40	
2	Aut002 40.7-1.35	
3	Aut003 2.30-1.35	
4	Aut004 3.2-1.80	
5	Aut005 POSTO AUTO TIPO 5.00-2.50	
6	Aut006 POSTO AUTO TIPO PER PORATORI DI HANDICAP 5.00-3.20	
7	Art01 18.39-2.45- 4.63	

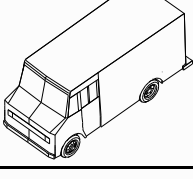
8	Art02 21.68-2.47- 4.66	
9	Art03 18.11-2.46- 4.68	
10	Art04 21.39-2.46- 4.68	
11	Artfc05 17.61-4.69	
12	Artfc06 20.98-4.67	
13	Artf07 2.41-4.67	
14	Artf08 2.40- 4.68	
15	Aut3d1 4.21-1.63- 1.28	
16	Aut3d2 4.21-1.88- 1.28	
17	Aut3d3 3.77-1.58- 1.33	

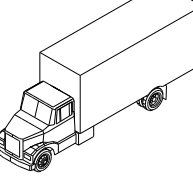
18	Aut3d4 4.57-1.61- 1.38	
19	Aut3d5 4.36-1.78- 1.17	
20	Aut3d6 4.25-1.71- 1.12	
21	Aut3d7 4.25-1.74- 1.13	
22	Aut3d8 4.35-1.77- 1.12	
23	Aut3d9 5.06-1.73- 1.71	
24	Aut3d10 4.24-1.82- 1.33	
25	Aut3d11 3.80-1.75- 1.21	
26	Autfc12 3.82-1.36	
27	Autfc13 4.64-1.39	
28	Autf14 1.58-1.37	

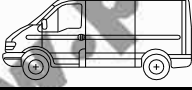
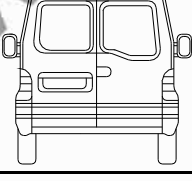
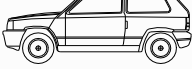
29	Auf15 1.68-1.39		38	Astrafn		51	Piator2	
30	Bus01 13.75-2.91-3.63		39	Astralat		52	Piatorr	
31	Busfc02 13.66-3.64		40	BMW2		53	Vanfrnt	
32	Busfc03 2.82-3.63		41	Camilat		54	Vanlat	
33	Carav1 7.05-2.40-3.00		42	Caralt		55	Vanretr	
34	Carav2 8.40-2.57-3.14		43	Carlat				
35	Furg01 6.64-2.21-2.87		44	Corsavan				
36	Furg02 6.33-2.53-2.84		45	Furgalt				
37	Furg03 10.23-2.42-4.06		46	Furgfrn				
			47	Furglat				
			48	Furgret				
			49	Pandlat				
			50	Pandvan	